

WHITEPAPER

# HEAT SHRINK TUBING TECHNOLOGY

---

Enabling Performance, Safety and Reliability in EV High Voltage Applications

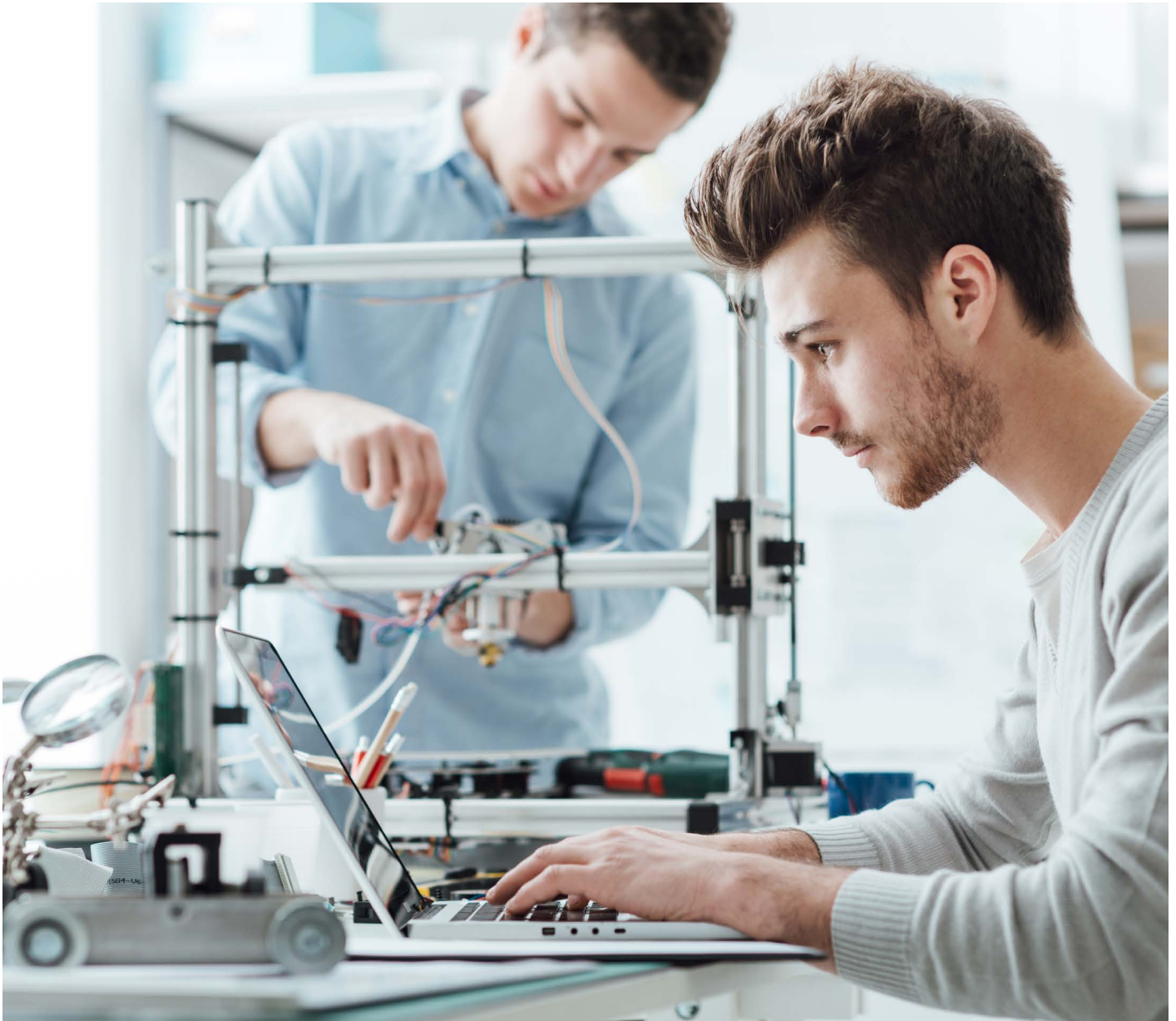

## INTRODUCTION

Manufacturers and operators of systems with complex electrical infrastructures need reliable, proven options to insulate components against heat and electric current, provide strain relief for connectors and joints/splices, and protect and seal electric cable, wiring and components against water ingress, exposure to chemicals and damage from abrasion or bending. Today, heat shrink tubing and components offers a versatile, reliable and cost-effective option to address all of these operational challenges. In recent years, the development and commercialization of co-extruded and triple-extruded heat shrink components have created additional ways to combine form and function. Specifically, co-extruded heat shrink parts benefit from the marriage of two high-performance materials, by combining an outer heat shrink thermoplastic layer with an inner elastomeric material. Once the single co-extruded tube or part is installed, its inner layer conforms more reliably to irregular surface, while the outer heat shrink layer protects the underlying electrical cable or component from challenges present in the surrounding environment.

This white paper provides an in-depth discussion of the inherent advantages that can result when heat shrink components and accessories are selected to terminate and connect electrical cables and connections, to maximize system reliability, reduce unplanned downtime, streamline field installation, and simplify the management of spare parts inventories to support routine maintenance and operation. With a focus on proper material selection and installation, the use of TE Connectivity (TE) heat shrink components can give system owners and operators peace of mind, and over the lifecycle of these installations, these premium products strive to pay for themselves, by stability, durability, and dependability to perform over an expected service lifetime of 40+ years, in harsh climate conditions.

### WHAT IS CONSIDERED “HIGH VOLTAGE” AND WHY IS IT IMPORTANT?

High voltage (HV) is a term used to describe electrical power systems and components that operate at voltages above defined limits.

In the UK, BS 7671, commonly known as the wiring regulations and published by the Institution of Engineering and Technology (IET), defines three distinct voltage range levels, and these are detailed in Table 1 below.

Voltage type	Voltage range	Range Description
AC	0 - 50V	Extra Low Voltage
DC	0 - 125V	Extra Low Voltage
AC	50-1000V	Low Voltage
DC	125 - 1500V	Low Voltage
AC	1000V+	High Voltage
DC	1500V+	High Voltage

Table 1 Voltage range levels according to BS 7671 in the UK



In the USA, the National Electrical Code (NEC) and the National Electrical Manufacturer’s Association (NEMA) have guidelines and standards that cover all voltage classifications.

Voltage type	Voltage range	Range Description
AC	0-49V	Low Voltage (LV)
AC	50-1000V	Medium Voltage (MV)
AC	1000-4160V	High Voltage



In Japan, the electricity sector in Japan is governed by the Electricity Business Act (EBA).

Voltage type	Voltage range	Range Description
AC	0-110V	Low Voltage (LV)
DC	0-220V	Low Voltage (LV)
AC	13-60kV	Medium Voltage (MV)
AC	-	High Voltage

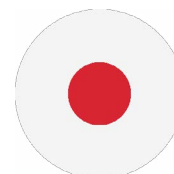

# Heat Shrink Tubing Technology

These basic ranges broadly categorise the potential risk associated with electrocution for the human being exposed to such levels. The potential consequences of voltage exposure are dependent on many factors, voltage level, current level, current pathway, frequency, duration, environmental conditions, and the characteristics of the individual (everyone is different). At extra low voltages, the resistance of the human skin is considered sufficient to impede any significant current flow through the human body. Above these levels for alternating current (AC) and direct current (DC), the voltage is considered sufficient to allow fatal levels of current to flow through the human as the resistance of the skin is overcome. For high voltage systems this risk is amplified for two reasons: 1) the resistance of the human body reduces as voltage increases, and 2) the voltage and associated electrical field are sufficient to breakdown air to “contact” the human body without the need to physically contact the live conductor. Fatal levels of current can be as low as 10mA dependent on the current pathway and duration. The International Electrotechnical Commission (IEC) gives values, under certain conditions, related to human body resistance. As an example, based on these conditions the 50th centile for the human body resistance is 3250Ω or 1050Ω at 25V or 1000V respectively. At 25 volts this would relate to a current of 7.7mA, whilst at 1000V it would be 0.97A (fatal).

Clearly there are major health and safety considerations when working with high voltage and high voltage systems, so why do we choose to work with high voltage? Whilst there are many reasons dependent on specific applications, use of high voltage results in either more efficient energy transmission or higher energy densities which are often crucial in system architectures. However, physical design of systems becomes much more complicated in high voltage systems due to changes in the electrical insulation characteristics of the surrounding air (for example, dry air will typically breakdown at an electrical field of 3kV/mm, whilst air with high Relative Humidity (RH) % will be lower).

## HIGH VOLTAGE AND THE ELECTRIC FIELD

Failure of insulation materials is driven by the electric field (E) which is related to the voltage (V) or potential difference. The electric field (E) is defined by the equation below and is a vector field, and therefore every point in space has both a magnitude and direction, whereas the voltage is a scalar field with each point having only a magnitude.

$$E = -\nabla.V = -\left(i \frac{\partial V}{\partial x} + j \frac{\partial V}{\partial y} + k \frac{\partial V}{\partial z}\right)$$

(This equation represents the gradient of the voltage in a three axis cartesian coordinate system, where i, j, and k represent the unit vectors in the x, y and z direction respectively).



In the simple case of a parallel plate arrangement, which is common for a material test geometry, this equation simplifies.

$$E = -\nabla.V = -i \frac{V}{x}$$

So for a sample of 2mm thickness (separated in the i direction) and an applied voltage of 20,000V (20kV), the E field would be 10kV/mm in the i direction. Any charged particles (e.g., electrons, ions) move along field lines and as the current is defined by

$$I = \frac{dq}{dt} \text{ (i.e., rate of flow of charge).}$$

Then the current flows from one plate across the material to the opposite plate, and this is true pre and post any electrical breakdown (pre breakdown current is referred to as leakage current and is often used to assess the resistance of material and cables).

For cable applications and heat shrink geometries, the E field is better described using a cylindrical polar coordinate form which is shown below.

$$E = (-) \frac{V}{r \left(\ln \left(\frac{A}{a}\right)\right)} \cdot \vec{r}$$

For the above formula, the electric field “E” is in the radial direction between the inner surface (radius “a” and the outer surface (radius “A”). “r” is the value between “a” and “A”, and so unlike the parallel plate arrangement the value of E changes as you transit along the radial direction “r”. In the above formula “V” is the potential difference between the inner and outer surfaces.

All the above formulas are accurate and appropriate up to electrical field values of 20kV/mm. Above 20kV/mm there will be non-linear high voltage phenomena which cause deviation in the distribution of the electrical field. Above 100kV/mm these deviations can become more prominent due to quantum mechanical effects.

# Heat Shrink Tubing Technology

## HIGH VOLTAGE IN CONTEXT

In general, the voltage level considered as “high voltage” is relative to the context and application. In the UK the various voltage levels from transmission to low voltage domestic application is shown in the figure below.

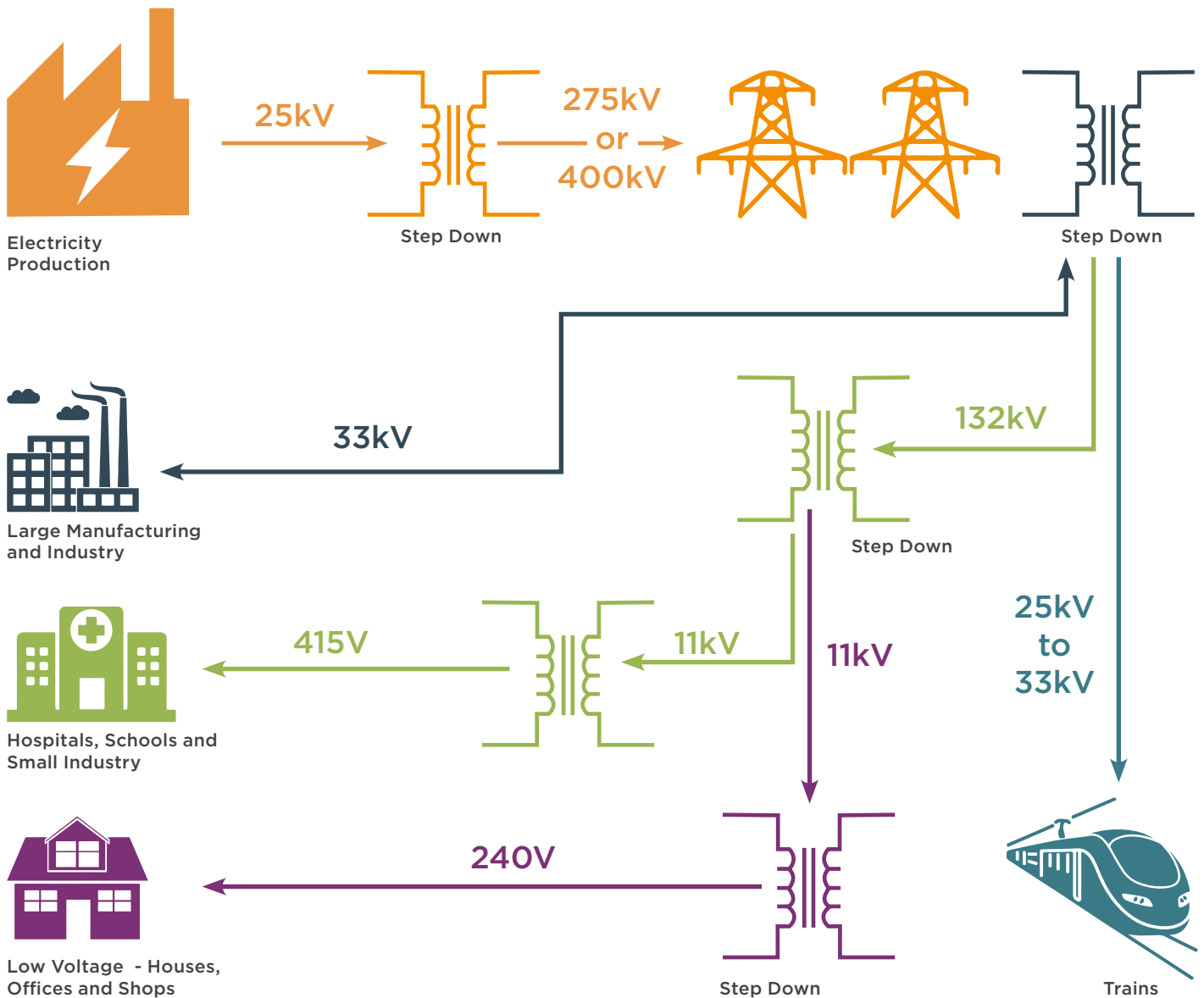

Figure 1.

In most countries, the definition of high voltage is set by regulations or standards organizations, and it typically ranges from 1000 volts (1 kV) to 69,000 volts (69 kV) for distribution and transmission of electric power.

The level of high voltage used in specific applications depends on the specific needs and requirements of that application. For example, some industrial processes require high voltages, while others may require lower voltages with high current. In the field of electric power transmission and distribution, high voltage is used to transmit power over long distances with minimised losses.

In summary, the definition of high voltage varies depending on the application and country, and it is typically set by regulatory bodies or industry standards organizations. High voltage is used for different purposes, including power transmission and industrial processes, and the specific voltage level required depends on the application.

# Heat Shrink Tubing Technology

## CHAPTER 1 - KEY GROWTH DRIVERS DRIVING DEMAND FOR HV HEAT SHRINK SOLUTIONS -

### Electrification

Electric vehicles are becoming highly connected as part of the internet of things and the internet of vehicles, transforming the vehicle into a seamless interface between our connected lives at home and work. The integration of screens and displays into almost any imaginable interior surface demonstrates the vehicle's growing role as a hub for entertainment, communications, and productivity. The automotive industry has worked with major technology companies in order to deliver the most advanced, safest and most comfortable vehicles out there. Cars are becoming large smart devices with advanced emergency braking capabilities, mapping technology for autonomous driving, better fuel efficiency and cars as a service as a form of transportation. One of the key drivers of the electric vehicle heat shrink tubing industry is demand for electric vehicles and sales worldwide. Electric vehicles (EVs) require the use of high voltage cables and wiring for power transmission. These cables need to be protected from heat, moisture, and mechanical stress.

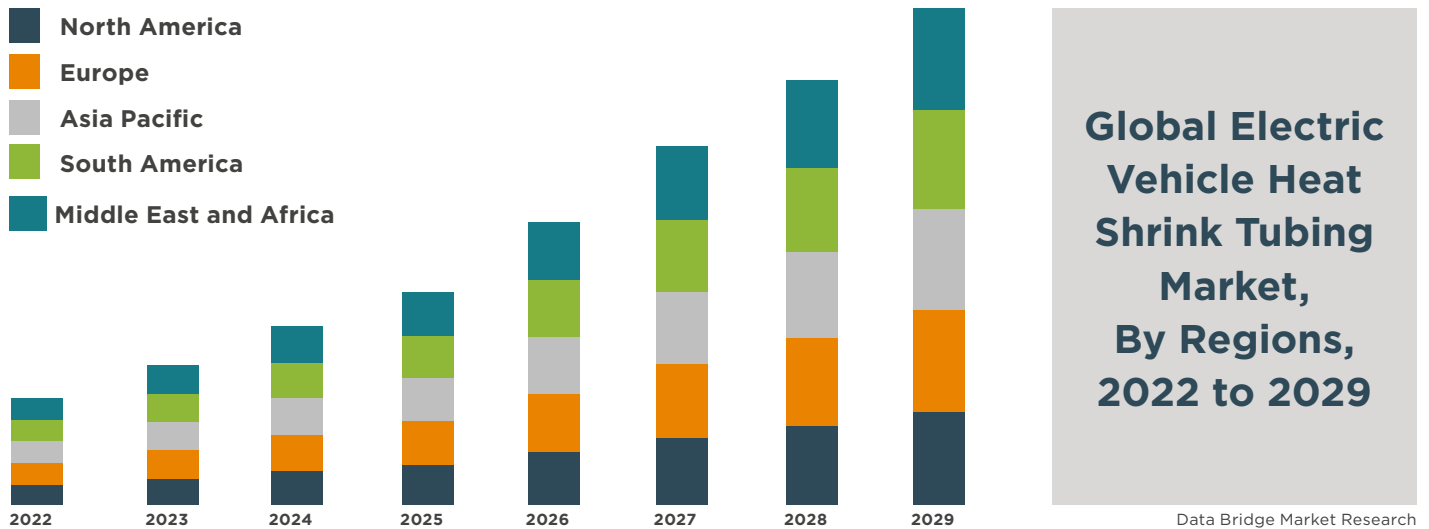

### Renewable Energy

The increasing demand for renewable energy sources such as wind turbines, solar panels, and hydroelectric power plants requires high voltage cables and wiring that need to be insulated and protected from environmental conditions. High voltage heat shrink tubing is essential in helping ensure the safety and reliability of these systems.

### Industrial Automation

The trend towards industrial automation requires the use of high voltage cables and wiring for power transmission and control. These cables need to be protected from harsh environments such as high temperatures, humidity, and chemicals. High voltage heat shrink tubing can be an effective solution to protect these cables.

### 5G Technology

The deployment of 5G technology requires the use of high voltage cables and wiring for power transmission and data communication. These cables need to be protected from interference, moisture, and other environmental factors. High voltage heat shrink tubing is an excellent solution for protecting these cables.



### Infrastructure Development

The increasing investment in infrastructure development, such as smart cities and high-speed railways, requires the use of high voltage cables and wiring for power transmission. These cables need to be protected from harsh environments and physical damage. High voltage heat shrink tubing can be an effective solution for protecting these cables.



## CHAPTER 2 – ADDRESSING HV INSULATION CHALLENGES

Electrical insulation materials can come in solid, liquid and gas form dependent on the given application. For high voltage transmission, air becomes the dominant insulation material for overhead power lines, whilst gases such as sulfur hexafluoride (SF6) are used for switch gear applications as SF6 helps suppress internal discharge activity. Modern cable insulation systems tend to be solid polymeric based systems which may also be cross-linked during production.

Solid polymeric materials are used in many electrical applications and appliances, and this is either thermoplastic in nature (i.e., polyethylene, polypropylene, PET, EVA, EMA etc.) or thermosetting type resins like epoxy (e.g. for PCB's) or polyurethane based systems. For higher fidelity or more challenging environments PTFE or PVDF (e.g., Kynar brand) solutions could be considered, but at increased cost. Silicone rubbers are also commonly used for higher temperature type applications along with polyimide based films.

Failure modes can be split into 5 major categories all associated with energy, and these are detailed in Table 2.

Energy Type	Energy Sub Type	Failure Mode
Thermal	High Temperature	<ul style="list-style-type: none"> <li>Thermal degradation due to thermal induced chemical reaction or decomposition</li> <li>Mechanical failure due to changes of material property</li> </ul>
	Low temperature	<ul style="list-style-type: none"> <li>Electro-thermal failure due to increased current flow at elevated temperature</li> <li>Combustion / flammability</li> <li>Loss of flexibility leading to cracking,</li> <li>Loss of dimensional conformity or sealing capability</li> </ul>
Mechanical	Shock Vibration Compression (constant) Tension (constant) Shear Bending / flexing Abrasion	<ul style="list-style-type: none"> <li>Fracture / splitting</li> <li>Mechanical fatigue and fracture</li> <li>Creep, fracture, loss of dimensional conformity</li> <li>Creep, yield loss of dimensional conformity</li> <li>Fatigue / creep, cracking, fracture, delamination</li> <li>Mechanical fatigue and fracture / splitting</li> <li>Loss of surface material leading to failures in other categories</li> </ul>
Electrical	AC DC High Voltage RF	<ul style="list-style-type: none"> <li>Heating, fire (mains current levels due to dielectric and conduction heating)</li> <li>Heating, fire (mains current levels – conduction heating)</li> <li>Dielectric / insulation breakdown, Partial discharge, electrical surface tracking and flashover (see 3)</li> <li>Localised surface heating and thermal degradation</li> </ul>
Chemical	Water and Moisture Organic fluids / solvents Oils Petrochemicals Corrosive	<ul style="list-style-type: none"> <li>Failures associated with increased electrical conductivity (3, 12, 13, 14, 15)</li> <li>Dimensional distortion and non-conformance</li> <li>Dimensional distortion and swelling, possible dissolving and loss of mechanical integrity</li> <li>Dimensional distortion and swelling / chemical compatibility</li> <li>Chemical attack of material leading to removal of insulation system and mechanical integrity</li> </ul>
Radiation	UV X-ray ( $\alpha$ , $\beta$ , Gamma, neutron)	<ul style="list-style-type: none"> <li>Embrittlement, discolouration, degradation</li> <li>Bond scission and loss of material integrity over time Not considered in this paper</li> </ul>

Table 2. Major failure modes associated with polymer insulation systems

Base Polymer	Characteristics
PVDF	<ul style="list-style-type: none"> <li>Pros - Excellent chemical resistance, abrasion resistance, flame resistance and temperature and UV stability</li> <li>Cons - Cost</li> </ul>
PTFE	<ul style="list-style-type: none"> <li>Pros - Excellent chemical resistance, low friction, excellent insulation and dielectric properties (I.e. low loss, low conductivity)</li> <li>Cons - Cost</li> </ul>
Polyethylene (PE)	<ul style="list-style-type: none"> <li>Pros - Commonly used, excellent electrical insulation and dielectric characteristics, good chemical resistance (not to organic solvents), moderate mechanical properties, processability, cost, hydrophobic</li> <li>Cons - Low dielectric constant, relatively low operational temperature range &lt; 135°C</li> </ul>
Polypropylene (PP)	<ul style="list-style-type: none"> <li>Pros - Good impact strength and mechanical properties (good energy dispersion under impact conditions), higher melt temperature than PE, good insulation properties and low dielectric loss, good chemical resistance (not to organic solvents)</li> <li>Cons - Low dielectric constant</li> </ul>
Ethylene vinyl acetate (EVA)	<ul style="list-style-type: none"> <li>Pros - Good adhesive properties, very flexible, also acts as processing aid when compounded with other polymers in copolymer systems</li> <li>Cons - Very low melt temperature, relatively poor electrical insulator, prone to moisture absorption</li> </ul>
Ethylene methyl acrylate copolymer (EMA)	<ul style="list-style-type: none"> <li>Pros - Accept high level of fillers / additives, thermal stability, flexibility and adhesion</li> <li>Cons - Moisture absorption, temperature limited to 135°C</li> </ul>
Polyethylene Terephthalate (PET)	<ul style="list-style-type: none"> <li>Pros - Good electrical properties (especially in thin film form), good thermal stability</li> <li>Cons - Moisture absorption</li> </ul>

Table 3. Common polymers used for electrical applications including heat shrink viability.

# Heat Shrink Tubing Technology

When it comes to high voltage applications, it is important to choose a heat shrink tubing material that can withstand the high voltages involved without breaking down or failing. Here are some of the best high voltage heat shrink tubing materials:

- **Polyolefin heat shrink tubing:** Polyolefin tubing can be a good choice for high voltage applications up to around 2500 volts. It offers excellent electrical insulation and resistance to chemicals and UV radiation, making it suitable for a wide range of applications. The voltage range is really limited by the level of additives utilised to achieve flammability properties and increased thermal stability.
- **Silicone heat shrink tubing:** Silicone tubing is highly resistant to high temperatures and can typically withstand voltages up to around 10kV. It is often used in high temperature applications such as automotive wiring and electronic equipment.
- **Ethylene propylene diene monomer (EPDM) heat shrink tubing:** EPDM is an exceptionally durable and flexible material that can withstand relatively high temperatures (up to 150°C) and is resistant to a wide range of chemicals and environments. It is often used in high voltage applications up to 35kV, such as in power distribution and electrical equipment where thicker walls are possible due to the inherent material flexibility.
- **Fluoropolymer heat shrink tubing:** Fluoropolymer tubing made from materials such as PVDF is highly resistant to chemicals and can withstand elevated temperatures and high voltages. It is often used in harsh environments such as chemical processing plants and aerospace applications.
- **PVC heat shrink tubing:** PVC tubing can offer good electrical insulation and can withstand voltages up to around 2kV. However, it may not be the best choice for high temperature applications, as it can become brittle and break down over time.

The best high voltage heat shrink tubing material for a given application depends on several factors, including the specific voltage and temperature requirements, the level of chemical exposure, and other environmental factors. It is important to choose a high-quality tubing material and follow proper installation techniques to ensure a safe and reliable electrical system.

## CHAPTER 3 - TAPE VS. HEAT SHRINK VS. COLD SHRINK

### Tape

Electrical tape is a type of pressure-sensitive tape used to insulate and protect electrical wires. It can be made of different plastics like vinyl, rubber, mastic, and varnished cambric. Vinyl is the most widely used material for electrical tape. Electrical tape has high flexibility, which allows it to be used in many applications.

Electrical tape also comes in many different colors. It can be used for insulation, bundling, repair, and identification.



### Cold Shrink Tubing

Although heat shrink and cold shrink tubing look almost identical from the surface, their internal characteristics are incredibly different. Each of the tubing types has a different insulation technique, different applications, and different physical properties. The tubing can be for various applications including splicing, terminating, and environmental seals. This kind of tubing is more cost effective and easier on the environment than most other similar tubing.

Cold shrink tubing comes stretched over a removable plastic core, allowing the tube to be slid over the application, and the core removed so that the tubing contracts to create a watertight seal around the cable or connection due to the ‘active memory’ contained within the EPDM rubber or silicone material. Heat shrink tubing also comes pre-stretched but as a sleeve rather than over a removable core. The sleeve requires a heat source for installation, often from a gas torch, to heat the polyolefin tubing so that it shrinks to its original size, creating a seal over the cable or joint.

Silicone-rubber cold shrink tubing has the greater UV-resistance of all the types of cold or heat-applied tubing and is therefore used in outdoor, exposed environments, for example: trackside terminations to rail power lines. EPDM rubber is also used in cold shrink tubing and is much more abrasion resistant than other cold or heat-applied products, being ideally suited for direct burial applications such as cable-to-cable jointing.

Cold shrink tubing has an “active memory” seal characteristic, meaning the tubing is always trying to return to its original size and able to maintain its sealing capability around cables as it expands and contracts under large load-swings or temperature fluctuations.

Another advantage of cold shrink tubing is that because there is no direct flame required to install components, there is a reduced risk to the installer, especially in the presence of combustible gasses. Hot-work permits are not required, and quality and reliability of the installation is guaranteed due to fewer critical installation techniques, with resultant time and cost savings.

# Heat Shrink Tubing Technology

## Heat Shrink Tubing

Heat shrink tubing is used in wire harnessing processes to insulate wire connection, protect wires, and create cable entry seals. Manually performing this sensitive process can be time-consuming, the results are heavily reliant on the operator's expertise, and the process can raise safety concerns.

	Shrink Ratio	Operating Temperature	Minimum Full Recover Temperature	Color Options	Flammability rating	Standard Size Range	Approvals/Mil-Spec	Applications	Products
Single wall Heat Shrink Tubing	2:1 and 3:1	-30°C to 125°C  55°C to 135°C	90°C to 125°C	Black, White, Red, Green, Blue, Yellow, Brown, Orange, Violet Grey	ASTM D2671, Proc C; UL 224/CSA VW-1	3/4" to 5"	UL recognized/CSA certified  ASM-STD-23053	Shield splice protection, electrical insulation, Mechanical protection for hoses, noise reduction for pipes, insulation and strain relief for fine gauge wire and fiber optic cables, Moisture, fungus, and weather-resistant for outdoor application, thermal insulation of substrates, pipes, hoses and cables	RNF-100 RNF-300) Versafit CGPT LSTT DCPT SWFR
Dual wall Heat Shrink Tubing	2:1 to 6:1	-40°C to 130°C	135°C	Black, Red, Orange, Yellow,	Flame-retardant per ISO 6722 UL File E85381	1/8" to 4"	UL recognized/CSA certified	Sealing and protecting connector backshells, breakouts and connector-to- cable transitions, repair damaged cable jackets without removing connectors, environmental protection of electrical components, protect temperature sensitive components and wires	ATUM ES-1000 ES-2000 AP2000 DWFR DWHF TATA-125 QSZH

Heat shrink tubing and electrical tape have their similarities, but their differences are what stand out the most. Both materials are used for electrical insulation, come in different colors, and are fairly easy to apply. However, that is where the similarities stop.

Heat shrink tubing comes in predetermined shrink ratios. This allows for a more precise fit when applying. Heat shrink tubing also has a larger variety of materials that are specific to different applications. Electrical tape has a few different materials, but the most commonly used is vinyl.

Heat shrink tubing is also more reliable. It will not come off with time or use, where the electrical tape will eventually lose its adhesiveness. Electrical tape also will not perform as well in applications that have a substantial risk of being affected by outside influences such as chemicals and abrasion.

When compared to heat shrink tubing, electrical tape is easier to apply and remove. Although both are fairly simple to

apply, once heat shrink tubing is shrunk to fit, it will be secure and not as easy to remove as peeling off the electrical tape. Electrical tape also offers a quick way to identify voltage by its many colors and phasing.

These products may seem similar at first, but when they are closely examined, their differences outweigh their similarities.



	Rigidity	Flexibility	Humid environment	Mechanical protection	Chemical resistance	UV resistant	Strain Relief	Environment
Heat shrink tubing	✓	✓	-	✓	✓	✓	✓	Industrial automation Automotive Commercial Transportation
Cold shrink tubing		✓	✓			✓		Outdoors
Electrical tape								Should only be used as a temporary measure



# Heat Shrink Tubing Technology

## CHAPTER 4 - MATERIALS AND THEIR BENEFITS

Heat shrink tubing is a type of insulation material that is designed to shrink when exposed to heat, creating a tight and secure seal around wires, cables, and other objects. The shrinking process is made possible by the macro-molecular nature of polymers where the geometry that is “locked in place” during cross-linking can be recovered after tube expansion by the simple application of heat. There are several diverse types of heat shrink tubing materials, each with unique properties and applications. Here is a brief overview of the most common types:

### Polyolefin heat shrink tubing

Polyolefin heat shrink tubing is a popular selection among heat shrink tubing because polyolefin is flame-retardant and possesses good chemical, electrical and physical properties. In general, polyolefin tubing is a reliable all-purpose heat shrink product and is UL recognized. Sometimes polyolefin heat shrink tubing is also referred to as automotive heat shrink tubing since it can be a desirable choice for automotive applications. However, depending on the specific application, another heat shrink tubing option may work better for your requirements. It is a durable material that can withstand much higher temperatures than PVC tubing, in the range of 125°C to 135°C (257°F to 275°F). Because of its higher temperature resistance, polyolefin tubing can have a longer shelf-life at normal temperatures and common environments.

### PVC heat shrink tubing

PVC tubing is known for its high clarity and durability, making it a popular choice for applications where aesthetics are important. PVC tubing is also resistant to water and chemicals but may not be as flexible as other materials. PVC tubing may only be used for applications with operating temperatures less than 105°C (221°F). Some of PVC’s benefits include low cost, good tensile strength and abrasion resistance, and color quality.

### Fluoropolymer heat shrink tubing

This type of tubing is made from high-performance fluoropolymers such as Teflon brand fluoropolymer, which provide exceptional chemical resistance and high-temperature performance. For challenging applications, heat shrink tubing may be made with fluoropolymers such as PTFE and FEP, or with PVDF, or, Kynar brand of PVDF, or Viton brand materials. Although these materials are much more expensive than

PVC or polyolefin, they are only necessary for applications requiring exceptional resistances or extremely high-temperature performance. Fluoropolymer tubing is often used in harsh environments such as chemical processing plants and aerospace applications.

### Silicone heat shrink tubing

Silicone tubing is known for its flexibility and resistance to extreme temperatures and chemicals. It is often used in high-temperature applications such as automotive wiring and electronic equipment.

The choice of heat shrink tubing material depends on the specific requirements of the application. Factors such as temperature range, chemical exposure, flexibility, and color may all play a role in selecting the appropriate material.

The choice of heat shrink tubing material depends on the specific requirements of the application. Factors such as temperature range, chemical exposure, flexibility, and color may all play a role in selecting the appropriate material.

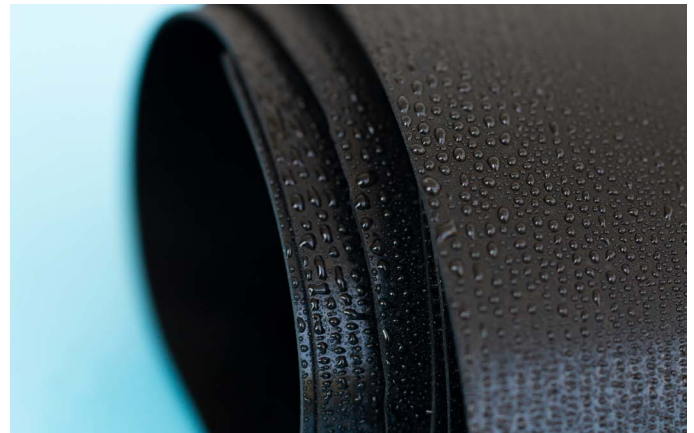

	Polyolefin	PVC (Polyvinyl Chloride)	Fluoropolymer	Elastomer
Material Description	An organic thermoplastic with a waxy texture that is odorless and non-porous	A polymer thermoplastic composed of 57% chlorine and 43% carbon; one of the most common plastics in the world	A fluorocarbon-based polymer with multiple carbon-fluorine bonds	A polymer with rubber-like viscoelastic properties
Material Properties	<ul style="list-style-type: none"><li>• Wider temperatures &gt;105°C (221°F) than PVC</li><li>• Excellent abrasion resistance</li><li>• Adhesive-lined dual-wall available</li><li>• Highly flexible</li><li>• Excellent chemical and electrical properties</li><li>• Highly flame retardant</li></ul>	<ul style="list-style-type: none"><li>• Lower cost than Polyolefin</li><li>• Limited to 105°C (221°F)</li><li>• Brighter, more vibrant colors</li><li>• Custom colors</li></ul>	<ul style="list-style-type: none"><li>• 40% thinner walls than most Polyolefin heat shrink</li><li>• High flame resistance</li><li>• Up to 135°C (275°F)</li></ul>	<ul style="list-style-type: none"><li>• Flexibility at low temperatures</li><li>• Resistant to most fluids and solvents</li><li>• Additional properties based on Elastomer formulation</li></ul>

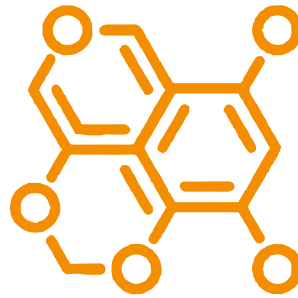

## POLYMER

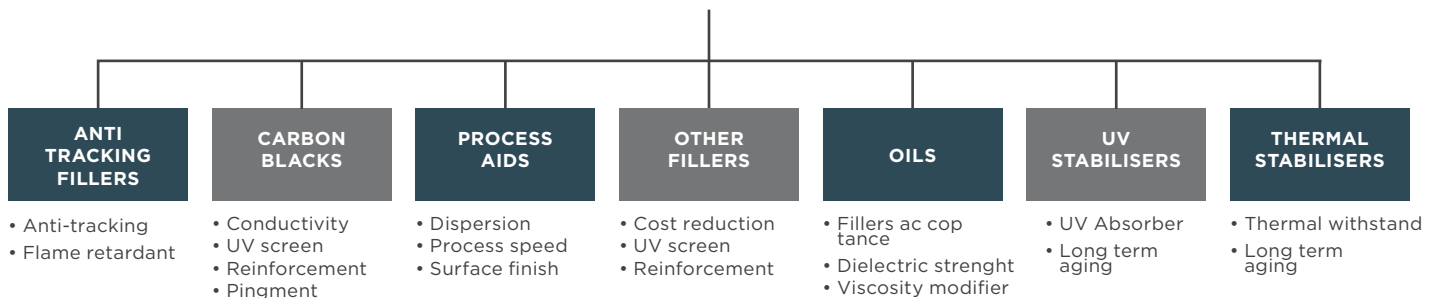

POTENTIAL INGREDIENTS TO FORMULATE HEAT SHRINK MATERIAL WITH THE DESIRED PROPERTIES

## CHAPTER 5 - ELECTRICAL PROPERTIES

### Resistivity

Electrical resistivity forms part of the wider dielectric properties of materials. Any material can be considered to have a dielectric response, but typically certain materials are dominated by specific properties. For example, metals are dominated by the conductivity “σ”, whereas highly insulating materials like polymers are dominated by the dipolar responses. It is these wider dielectric properties that give rise to energy storage or capacitive grading of fields in complicated geometries, but also the level of current flow.

$$\epsilon^*(\omega) = \epsilon'(\omega) - i\epsilon''(\omega)$$

The full complex permittivity is given by the above equation where  $\epsilon^*(\omega)$  is the complex value as a function of angular frequency ( $\omega=2\pi f$ ), in radians per second. The real and imaginary part of the permittivity are given by  $\epsilon'(\omega)$  and  $\epsilon''(\omega)$  and represent the energy stored and the energy dissipated per AC cycle respectively. Such a performance characteristic is often described by the term “tanδ” and is often described as the loss angle (the same methodology is also employed in describing the viscoelastic mechanical properties). The equation below gives “tanδ” but is described as the energy dissipated divided by the energy stored per AC cycle.

$$\tan\delta = \frac{\epsilon''(\omega)}{\epsilon'(\omega)}$$

The dipole strength, and density per unit volume impact both the real and imaginary part of the complex permittivity, whilst charge flow or conduction is captured as part of the imaginary permittivity only. The equation below describes the full complex permittivity based on a single dipolar relaxation response, based on the Havriliak and Negami semi-empirical form of the Debye dispersion relations (see references), with an additional conduction term.

$$\epsilon^*(\omega) = \epsilon_\infty + \frac{\epsilon_l - \epsilon_\infty}{(1 + (i\omega\tau)^{1-\alpha})^\beta} - i \frac{\sigma}{\epsilon_0\omega}$$

Dipolar response
DC conductivity  
Conduction response

In the above equation  $\epsilon_l$  and  $\epsilon_\infty$  are the low and high frequency permittivity (real) values, “ω” is angular frequency, “τ” is the relaxation time for the dipole, α and β are numerical constants between 0 and 1 that describe “flattening and skewedness” of relaxation response as a deviation from the basic exponential decay (pure Debye relaxation). NOTE: The permittivity of free space is denoted as  $\epsilon_0$  and is equal to  $8.854 \times 10^{-12} \text{ Fm}^{-1}$ . For materials which largely constitute C-C, or C-H bonds, the dipolar response is weak and the value of the relative permittivity (real) will likely be < 3. Such materials without additives or fillers will have a conductivity, (1/resistivity) value of less than  $1 \times 10^{-16} \text{ Siemens.m}^{-1}$  and



consequently will have very high dielectric strength ( $>200\text{kV/mm}$ ). The “ $\tan\delta$ ” for simple polymers is also very low, and for materials such as polyethylene, polypropylene or polystyrene it is less than  $1\times 10^{-4}$ , which is also true for PTFE (due to C-F bond symmetry), whilst materials like epoxy resins or PET are typically greater than  $1\times 10^{-3}$ . Polymer based systems which contain additives will impact the dielectric properties and dielectric strength. However such additives are included for other benefits such as flame retardancy and thermal stability as examples. Use of inorganic additives and fillers will introduce ionic bonds which typically have much higher dipole strengths and therefore, dependent on loading level, can significantly increase the value of the relative permittivity (real). Use of additives such as carbon black will increase the permittivity but will also significantly increase the electrical conductivity of the material, whilst inclusion of metal fillers will predominantly increase the conductivity making such materials good candidates for conductive gaskets and EMI shielding applications.

The above dielectric responses also form the foundation / limitations for test standards (e.g. ASTM D2671, Method 230A of British Standards) relating to volume resistivity as the contribution to the “leakage current” from dipolar alignment will initially be very significant, and it is only when the dipoles have fully aligned that a “steady-state” current is achieved that

an estimation of the conductivity (or resistivity) can be made using standard methods.

### Thermal Management

The electrical properties of heat shrink tubing depend on the type of material used to make the tubing, as well as its thickness and other factors. Some of the electrical properties of heat shrink tubing that are important to consider include:

- Dielectric strength: This is the ability of the material to resist electrical breakdown under high voltage and electrical field. Heat shrink tubing is typically designed to have a high dielectric strength so that it can provide effective insulation for electrical connections.
- Electrical Insulation resistance: This is the resistance of the material to the flow of electrical current. Heat shrink tubing is designed to have a high insulation resistance to prevent leakage of electrical current and reduce the risk of electrical breakdown.
- Operating temperature range: Heat shrink tubing is designed to operate within a specified temperature range. If the tubing is exposed to temperatures outside this range, its electrical properties will be affected. In the case of elevated temperatures this will result in significant increase in the conductivity.

# Heat Shrink Tubing Technology

- **Chemical resistance:** Heat shrink tubing may be exposed to a variety of chemicals, depending on the application. The tubing should be resistant to these chemicals to prevent degradation of its electrical properties.
- **Water resistance:** Heat shrink tubing is often used in outdoor or wet environments. The tubing should be water-resistant (hydrophobic or covered with a protective layer) to prevent moisture from affecting its electrical properties.

Overall, heat shrink tubing is designed to provide effective insulation and protection for electrical connections. Its electrical properties are carefully engineered to meet specifications so that it can perform its intended function in a variety of environments and applications.

## CHAPTER 5 - TESTING

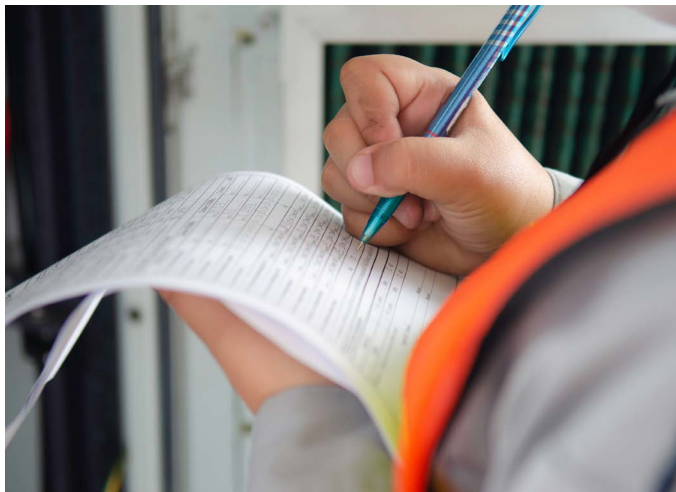

### UL

UL (Underwriters Laboratories) is a safety consulting and certification company that offers testing and certification services for various products, including heat shrink tubing.

UL testing for heat shrink tubing involves a series of tests to ensure that the product meets specific safety and performance standards. These tests may include:

- **Flammability Test:** This test determines the tubing's resistance to ignition and its ability to self-extinguish when exposed to a flame.
- **Tensile Strength Test:** This test measures the tubing's strength and ability to withstand tension and stretching.
- **Heat Aging Test:** This test evaluates the tubing's ability to withstand prolonged exposure to elevated temperatures.
- **Cold Bend Test:** This test assesses the tubing's flexibility at low temperatures.
- **Dielectric Withstanding Voltage Test:** This test checks the tubing's ability to resist electrical breakdown when subjected to high voltage.

**Water Absorption Test:** This test measures the tubing's ability to resist water absorption.

Once the heat shrink tubing has passed all the tests and meets the UL standards, it is certified for use in specific applications, such as electrical insulation or environmental sealing.

UL testing for heat shrink tubing is important because tests the product to defined standards, and it gives consumers confidence in the product's performance and safety.

### ASTM

ASTM (American Society for Testing and Materials) has several standards related to the testing of heat shrink tubing. Some of the most common standards are:

- **ASTM D2671 - Standard Test Method for Heat-Shrinkable Tubing for Electrical Use**
- This standard covers the requirements for heat shrink tubing used in electrical applications. It includes tests for measuring the tubing's electrical, physical, and chemical properties.
- **ASTM D792 - Standard Test Methods for Density and Specific Gravity (Relative Density) of Plastics by Displacement**
- This standard provides test methods for measuring the density of plastics, which is an important property to consider when selecting heat shrink tubing.
- **ASTM D638 - Standard Test Method for Tensile Properties of Plastics**
- This standard provides a method for measuring the tensile properties of plastics, including heat shrink tubing. The test measures the force required to break a specimen of the tubing and can provide information about the tubing's strength and flexibility.

**ASTM D2671/D2671M-13(2018) - Standard Specification for Heat-Shrinkable Tubing for Electrical Use**

This specification covers the requirements for heat shrink tubing used in electrical applications. It includes requirements for tubing size, shrink ratio, and other physical and electrical properties.

These standards are just a few examples of the many ASTM standards that may apply to heat shrink tubing. The relevant standards will depend on the intended use of the tubing and the application requirements.

### RoHS

RoHS stands for Restriction of Hazardous Substances, which is a European Union directive that restricts the use of certain hazardous substances in electrical and electronic equipment. The directive limits the amount of lead, cadmium, mercury, hexavalent chromium, polybrominated biphenyls (PBBs), and polybrominated diphenyl ethers (PBDEs) that can be present in electronic products.



# Heat Shrink Tubing Technology

---

Heat shrink tubing is used in electrical and electronic applications to provide insulation and protection for wires and cables. RoHS testing for heat shrink tubing typically involves testing for the presence of the restricted substances mentioned above. This is usually done using X-ray fluorescence (XRF) or inductively coupled plasma mass spectrometry (ICP-MS) analysis.

During the testing process, a small sample of the heat shrink tubing is analyzed to determine the concentration of any restricted substances. If the concentration is below the RoHS limits, the product is considered RoHS compliant. If the concentration is above the limits, the product is considered non-compliant and cannot be sold in the European Union.

RoHS compliance is important for manufacturers and suppliers of electrical and electronic products as non-compliant products can result in legal and financial consequences. It is also important for consumers as RoHS compliant products are considered safer for the environment and human health.

## VW

VW (Volkswagen) is an automotive company that has specific testing requirements for the products used in their vehicles, including heat shrink tubing. VW testing for heat shrink tubing involves a set of tests that ensure the tubing meets specific performance and quality standards.

The VW testing requirements for heat shrink tubing may include the following tests:

- **Tensile strength and elongation at break:** This test evaluates the tubing's ability to withstand stress and deformation.
- **Shrink temperature and time:** This test measures the tubing's shrinkage temperature and time, ensuring that the tubing shrinks to the desired dimensions.
- **Heat resistance:** This test evaluates the tubing's ability to withstand elevated temperatures and maintain its physical properties.
- **Electrical insulation resistance:** This test checks the tubing's ability to insulate and protect electrical components.
- **Chemical resistance:** This test assesses the tubing's resistance to chemicals, such as oils and fuels, that are commonly used in automotive applications.
- **Water absorption:** This test measures the tubing's ability to resist water absorption, which is important for ensuring the tubing's long-term performance.

The results of these tests are compared against the VW specifications to determine if the heat shrink tubing meets the requirements. Once the tubing has passed all the tests and meets the VW standards, it is certified for use in VW vehicles.

VW testing for heat shrink tubing is important because it ensures that the tubing meets the specific requirements for use in VW vehicles. It gives the company confidence that the product will perform reliably and meet the necessary safety and quality standards.

## CSA

CSA (Canadian Standards Association) is a non-profit organization that provides testing and certification services for a wide range of products, including heat shrink tubing. CSA testing for heat shrink tubing involves a series of tests to ensure that the product meets specific safety and performance standards for use in Canada.

The CSA testing requirements for heat shrink tubing may include the following tests:

- **Flammability test:** This test determines the tubing's ability to resist ignition and self-extinguish when exposed to a flame.
- **Dielectric voltage withstand test:** This test checks the tubing's ability to resist electrical breakdown when subjected to high voltage.
- **Tensile strength and elongation at break test:** This test measures the tubing's ability to withstand stress and deformation.
- **Shrink temperature and time test:** This test evaluates the tubing's shrinkage temperature and time, ensuring that the tubing shrinks to the desired dimensions.
- **Heat shock test:** This test evaluates the tubing's ability to withstand sudden temperature changes.
- **Chemical resistance test:** This test assesses the tubing's resistance to chemicals, such as oils and fuels, that are commonly used in various industries.
- **Water absorption test:** This test measures the tubing's ability to resist water absorption, which is important for ensuring the tubing's long-term performance.

The results of these tests are compared against the CSA specifications to determine if the heat shrink tubing meets the requirements. Once the tubing has passed all the tests and meets the CSA standards, it is certified for use in Canada.

CSA testing for heat shrink tubing is important because it ensures that the product meets the specific safety and performance requirements for use in Canada. It gives manufacturers, distributors, and end-users confidence that the product will perform reliably and meet the necessary safety and quality standards.



# Heat Shrink Tubing Technology

## CHAPTER 6: WHY CHOOSE TE'S HEAT SHRINK TUBING PRODUCTS: DESIGNED FOR HARSH AND RUGGED ENVIRONMENTS



As design engineers address the sealing, vibration and temperature challenges associated with many harsh environment applications, it's important to understand the benefits of heat shrink tubing:

- **Versatility and Durability:** Heat shrink tubing is designed to improve the ability to keep out moisture, harsh chemicals and mechanical interference. It also provides strain relief, electrical insulation, mechanical protection and environmental sealing for applications such as back-end connector sealing, breakouts, connector-to-cable transitions, and is especially useful in cable harnesses.
- **Quick Installation/High-Tech Performance:** Heat shrink tubing has a faster application time than other products resulting in better performance. For example, when compared to tape, heat shrink tubing has been shown to shorten application time (from 180 seconds to 45 seconds), improve yield (from less than 90% to over 98%) and provide a higher operational temperature rating (125°C compared to 105°C.)
- **Easy Installation:** When heated, heat shrink tubing conforms to the size and shape of the substrate beneath, enabling quick and easy installation. Its high expansion ratio of up to 8:1 can also enable users and technicians to repair most damaged cable jackets without removing other components such as connectors.
- **Safety:** Heat shrink tubing products are designed to maximize safety. This can include variables such as thick-tubing to secure extra protection, various colors for easy identification and various levels of flame-retardancy to meet UL VW-1 flammability standards.
- **Reliable, Robust Cross-linking Technology:** Cross-linking technology modifies the molecular structure of a polymer, allowing the tubing to withstand high temperatures without melting — a critical factor in harsh ICT environments. Heat shrink tubing can provide a complete seal and its high

mechanical strength makes it more resistant to impacts and abrasions.

- **Offered in Single Wall and Dual Wall Heat Shrink Tubing:** Single wall shrink tubing provides superior insulation strain relief and protection against mechanical damage and abrasion versus taping and molding in place. Dual wall tubing should be considered the top choice over taping, molding and potting for any circumstance where corrosion protection and sealing are required.

## CHAPTER 7: HEAT SHRINK TUBING MANUFACTURING PROCESS

Heat shrink tubing is manufactured using several steps where the various functionalities are added at various stages during the manufacturing process.



- **COMPOUNDING:** Compounding establishes the properties at the material level, this includes properties such as the flammability, colour, chemical resistance, and many thermo-mechanical properties (not all) are baselined at this stage.
- **EXTRUSION:** Extrusion is where the material pellets / powder are thermo-mechanically processed and extruded into a tube product of predetermined dimensions. This stage of the process will also establish the surface finish, but also the degree of longitudinal anisotropy in the polymer chains.
- **BEAMING:** “beaming” is the process of exposing the extruded tubing to a controlled level / total dose of radiation. This exposure is required to create a cross linking structural network within the tubing product and provides the “memory” necessary to recover its dimensions. The level of beaming will impact some of the baseline thermo-mechanical properties including the mechanical strength, the elongation / flexibility characteristics, and the upper thermal utilisation temperature. Whilst “beaming” promotes cross-linking within the material formulation it can also create bond scission in the polymer chains and so the dose level is carefully selected to provide a solution meeting the cross-linking requirement, but also to ensure appropriate visco-elastic properties.

# Heat Shrink Tubing Technology

- **EXPANSION:** The final stage of generating heat shrink tubing is the expansion process, whereby the tube is expanded in the radial direction to a controlled extent which provides a degree of radial anisotropy. This provides a larger size of tube diameter but with a thinner wall. The level of expansion will determine the heat shrink ratio, with values of 2:1, 3:1 and 4:1 being most common. The heat shrink product is supplied in its expanded form ready for application. In applying heat and thermal energy to the molecular chains of the polymer tubing the anisotropic chains will “relax” back to the form that was “memorised” during the cross linking / beaming stage of the process and the tube will look to recover its original dimensions prior to expansion. As there is a degree of longitudinal anisotropy imparted during the extrusion process the tube product will also undergo a degree of longitudinal change and will typically shorten. During application the heat shrink ratio and longitudinal change are important to consider when selecting the correct dimensions of a product for a given application.

## THE TE ADVANTAGE



TE’s Raychem brand of tubing has been the market leader for over 50 years—beginning when Raychem Corporation scientists pioneered the application of radiation cross-linking and developed heat-shrinkable polymer products and continuing over half a century, innovating product designs and setting the standard for the industry. Since the acquisition of Raychem Corporation in 1999, TE has upheld this strong legacy and continues to be on the cutting edge of heat shrink tubing technology today. As a provider of Raychem tubing products and as global leading brand, TE offers:

- Complete tubing product portfolios covering many industry applications
- Premium tubing product quality from abundant R&D and application experience, as well as excellent process controls
- Ability to meet various specs and certifications (including clean rooms for medical and military specs such as SAE 23053 and MIL-PRF-46846)
- Tubing design capability to meet specific needs and solutions
- 3 tubing manufacturing sites to cover key regions globally

- Strong global sales services, including great channel partner support

TE remains committed to meeting the needs of our customers, delivering quality products and identifying opportunities for more efficiencies, cost-savings and innovations in design. Finding ways to solve customer problems and increase reliability and performance in harsh environments are just some of the ways TE lives up to its purpose of creating a safer, sustainable, productive and connected future.

## BONUS: HEAT SHRINK TUBING INSTALLATION DO’S AND DON’TS:

- Do not force the supplied tube over something by stretching it. This can cause it to tear during recovery.
- Since heat shrink tubing is supplied at a minimum expanded diameter, always use the specified expanded inside diameter (ID) dimension. Do not assume that the tube will be delivered at exactly the same dimension every time. However, it will always meet the specified minimum expanded ID dimension.
- Do not assume the tube will always shrink to the same fully-recovered dimensions. Always use the specified dimensions for the recovered internal diameter of the tube. Sometimes the tube will shrink a little more than the recovered ID dimension specified, but it will meet the maximum specified dimension.
- Do not cut the tube length to be the final installed length required. The tube will change length during recovery. The more you shrink it the greater the longitudinal change. The longitudinal change is noted in the product specification. Use it when calculating the cut length.
- Do not recover the tubing over something with sharp edges, as they can cut the tubing or puncture it which results in the tubing splitting during installation.
- Follow the installation guidelines, especially the guideline on temperature. At too low a temperature the tubing may not fully recover. At too high a temperature it may show burn marks or split.
- If you use a heat gun to recover the tubing, expect to see some wrinkles. This is caused by non-uniform heating of the tubing (chill marks). However continued heating of the chill marks will make them disappear, but generally chill marks have no effect on the performance of the tube.
- Recommended recovery is in an oven to give uniform recovery around the entire circumference of the piece, or with a heat gun that allows the substrate to come up to temperature and assists in full recovery.

If you have any questions when selecting which size tubing is appropriate for your application, please consult with one of our experts.

---

## CONCLUSION

Manufacturers face countless design requirements to meet the most rugged of performance demands, as well as new challenges brought on by ever-changing market trends and evolving market needs like the rise of electrification and high voltage electrical sealing and protection. TE Connectivity's Raychem brand heat shrink tubing solutions are designed to help manufacturers meet a wide range of needs and conditions.

Through deep engineering capabilities and a commitment to testing, specific design requirements and certifications are achieved with reliability and dependability. With three major manufacturing sites for heat shrink tubing products to cover key regions globally, TE offers strong global sales services for heat shrink tubing solutions, including great channel partner support.

## TE CONNECTIVITY

TE Connectivity is a global technology leader offering complete product portfolios across a wide range of industry applications. TE remains committed to meeting the needs of our customers, delivering quality products, and identifying opportunities for more efficiency, cost-savings and innovations in design. Finding ways to solve customer problems and increase reliability and performance in harsh environments are just some of the ways TE lives up to its purpose of creating a safer, sustainable, productive, and connected future.

## REFERENCE SOURCES

**Electric Vehicle Market Forecast 2023-2030. (databridgemarketresearch.com)**

**<https://www.globenewswire.com/en/news-release/2022/11/29/2563633/0/en/Electric-Vehicle-Heat-Shrink-Tubing-Market-to-Witness-Substantial-Growth-of-USD-83-104-05-Thousand-by-2029-Size-Share-Trends-Growth-Major-Developments-and-Competitors-Insight.html>**

**High Temperature Insulation Materials Market – Global Industry Trends and Forecast to 2028 | Data Bridge Market Research**

**[https://en.wikipedia.org/wiki/Heat-shrink\\_tubing](https://en.wikipedia.org/wiki/Heat-shrink_tubing)**

**<https://blog.epectec.com/what-is-heat-shrink-tubing-and-how-is-it-used>**

**S. Havriliak and S. Negami, “A Complex Representation of Dielectric and Mechanical Relaxation Processes in Some Polymers”, Polymer, Vol. 8 pp161-210.**

## NOTICE

While TE Connectivity has made every reasonable effort to ensure the accuracy of the information in this document, TE Connectivity does not guarantee that it is error-free, nor does TE Connectivity make any other representation, warranty, or guarantee that the information is accurate, correct, reliable or current. TE Connectivity reserves the right to make any adjustments to the information contained herein at any time without notice.

TE Connectivity expressly disclaims any liability and all implied warranties regarding the information contained herein, including, but not limited to, any implied warranties of merchantability or fitness for a particular purpose. TE Connectivity's obligations shall only be as set forth in TE Connectivity's Standard Terms and Conditions of Sale for this product and in no case will

TE Connectivity be liable for any incidental, indirect or consequential damages arising out of the sale, resale, use or misuse of the product. Users of TE Connectivity products should make their own evaluation to determine the suitability of each such product for the specific application.

---

## [te.com/heatshrinktubing](https://te.com/heatshrinktubing)

TE, TE Connectivity, TE connectivity (logo), and EVERY CONNECTION COUNTS are trademarks owned or licensed by the TE Connectivity Ltd. family of companies. Other product names, logos, and company names mentioned herein may be trademarks of their respective owners.

The information given herein, including drawings, illustrations and schematics which are intended for illustration purposes only, is believed to be reliable. However, TE Connectivity makes no warranties as to its accuracy or completeness and disclaims any liability in connection with its use. TE Connectivity's obligations shall only be as set forth in TE Connectivity's Standard Terms and Conditions of Sale for this product and in no case will TE Connectivity be liable for any incidental, indirect or consequential damages arising out of the sale, resale, use or misuse of the product. Users of TE Connectivity products should make their own evaluation to determine the suitability of each such product for the specific application.

© 2023 TE Connectivity. All Rights Reserved.

06/23 Original